

## N-Channel MOSFET

### IRF840S (KRF840S)

#### ■ Features

- $V_{DS} (V) = 500V$
- $I_D = 8 A (V_{GS} = 10V)$
- $R_{DS(ON)} < 0.85 \Omega (V_{GS} = 10V)$
- Fast switching
- Low thermal resistance

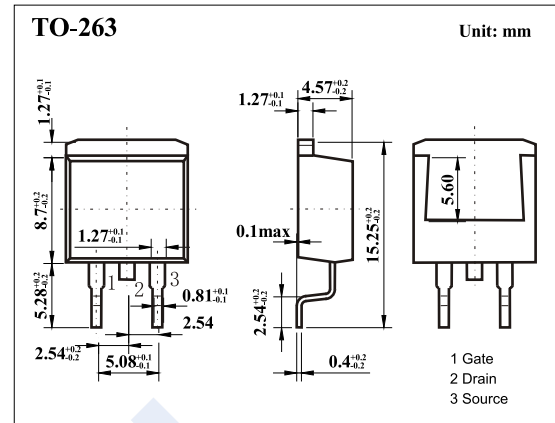
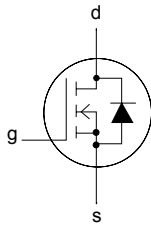

#### ■ Absolute Maximum Ratings $T_a = 25^\circ C$

Parameter	Symbol	Rating	Unit
Drain-Source Voltage	$V_{DS}$	500	V
Gate-Source Voltage	$V_{GS}$	$\pm 20$	
Continuous Drain Current	$I_D$	$T_a = 25^\circ C$	A
		$T_a = 100^\circ C$	
Pulsed Drain Current	$I_{DM}$	32	W
Avalanche Current	$I_{AR}$	8	
Power Dissipation	$P_D$	$T_c = 25^\circ C$	
		$T_a = 25^\circ C$	3.1
Non-Repetitive Avalanche Energy (Note.1)	$E_{AS}$	510	mJ
Repetitive Avalanche Energy	$E_{AR}$	13	
Peak Diode Recovery $dv/dt$ (Note.2)	$dv/dt$	3.5	V/ns
Thermal Resistance Junction- to-Ambient	$R_{thJA}$	60	$^\circ C/W$
Thermal Resistance Junction to Mounting Base	$R_{thJB}$	0.85	
Junction Temperature	$T_J$	150	$^\circ C$
Storage Temperature Range	$T_{stg}$	-55 to 150	

Note.1:  $L = 14mH$ ,  $I_{AS} = 8A$ ,  $V_{DD} = 50V$ ,  $R_G = 25\Omega$ , Starting  $T_J = 25^\circ C$ .

Note.2:  $I_{SD} \leq 8 A$ ,  $di/dt \leq 100A/\mu s$ ,  $V_{DD} \leq V_{(BR)DSS}$ , Starting  $T_J \leq 25^\circ C$ .

## N-Channel MOSFET

### IRF840S (KRF840S)

#### ■ Electrical Characteristics Ta = 25°C

Parameter	Symbol	Test Conditions	Min	Typ	Max	Unit
Drain-Source Breakdown Voltage	V <sub>DSS</sub>	I <sub>D</sub> =250 μA, V <sub>GS</sub> =0V	500			V
Zero Gate Voltage Drain Current	I <sub>DSS</sub>	V <sub>DS</sub> =500V, V <sub>GS</sub> =0V			25	μA
		V <sub>DS</sub> =400V, V <sub>GS</sub> =0V, T <sub>J</sub> =125°C			250	
Gate-Body Leakage Current	I <sub>GSS</sub>	V <sub>DS</sub> =0V, V <sub>GS</sub> =±20V			±100	nA
Gate Threshold Voltage	V <sub>GS(th)</sub>	V <sub>DS</sub> =V <sub>GS</sub> , I <sub>D</sub> =250 μA	2		4	V
Static Drain-Source On-Resistance	R <sub>DS(on)</sub>	V <sub>GS</sub> =10V, I <sub>D</sub> =4.8A (Note.1)			0.85	Ω
Forward Transconductance	g <sub>FS</sub>	V <sub>DS</sub> =50V, I <sub>D</sub> =4.8A (Note.1)	4.9			S
Input Capacitance	C <sub>iss</sub>	V <sub>GS</sub> =0V, V <sub>DS</sub> =25V, f=1MHz		1300		pF
Output Capacitance	C <sub>oss</sub>			310		
Reverse Transfer Capacitance	C <sub>rss</sub>			120		
Total Gate Charge	Q <sub>g</sub>	V <sub>GS</sub> =10V, V <sub>DS</sub> =400V, I <sub>D</sub> =8A			63	nC
Gate Source Charge	Q <sub>gs</sub>				9.3	
Gate Drain Charge	Q <sub>gd</sub>				32	
Internal Drain Inductance	L <sub>D</sub>	Between lead, 6 mm (0.25in.) from package and center of die contact		4.5		nH
Internal Source Inductance	L <sub>S</sub>			7.5		
Turn-On DelayTime	t <sub>d(on)</sub>	V <sub>DD</sub> = 250 V, I <sub>D</sub> = 8 A, R <sub>g</sub> = 9.1Ω, R <sub>D</sub> = 31Ω (Note.1)		14		ns
Turn-On Rise Time	t <sub>r</sub>			23		
Turn-Off DelayTime	t <sub>d(off)</sub>			49		
Turn-Off Fall Time	t <sub>f</sub>			20		
Body Diode Reverse Recovery Time	t <sub>rr</sub>	T <sub>J</sub> = 25°C, I <sub>F</sub> = 8A, dI/dt = 100A/μs			970	μs
Body Diode Reverse Recovery Charge	Q <sub>rr</sub>				8.9	
Continuous Source-Drain Diode Current	I <sub>S</sub>	MOSFET symbol showing the integral reverse p-n junction diode.			8	A
Pulsed Diode Forward Current	I <sub>SM</sub>				32	
Diode Forward Voltage	V <sub>SD</sub>	I <sub>S</sub> =8A, V <sub>GS</sub> =0V, T <sub>J</sub> = 25°C			2	V

Note.1: Pulse Test : Pulse width ≤ 300μs, Duty cycle ≤ 2%.

## N-Channel MOSFET IRF840S (KRF840S)

■ Typical Characteristics

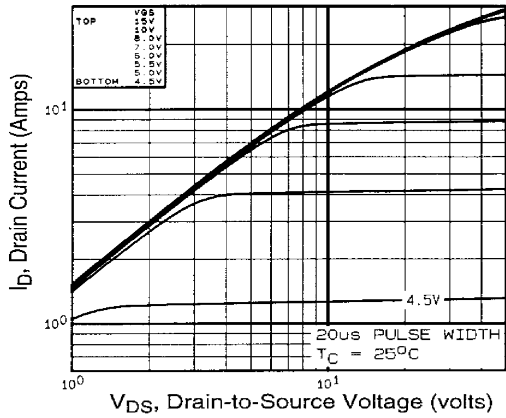

**Fig 1.** Typical Output Characteristics,  $T_C=25^\circ\text{C}$

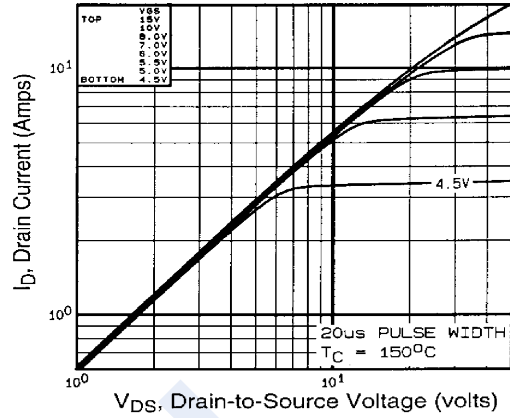

**Fig 2.** Typical Output Characteristics,  $T_C=150^\circ\text{C}$

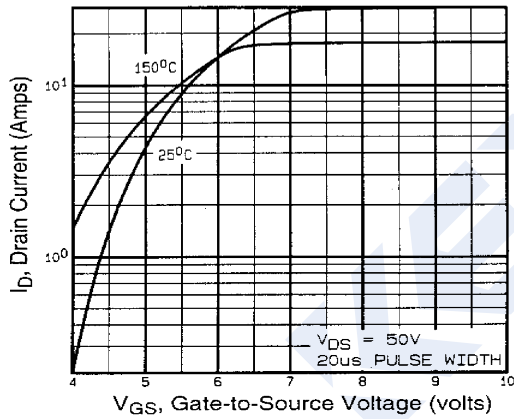

**Fig 3.** Typical Transfer Characteristics

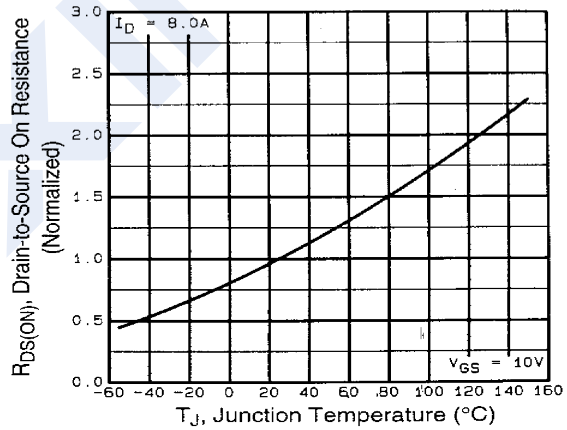

**Fig 4.** Normalized On-Resistance Vs. Temperature

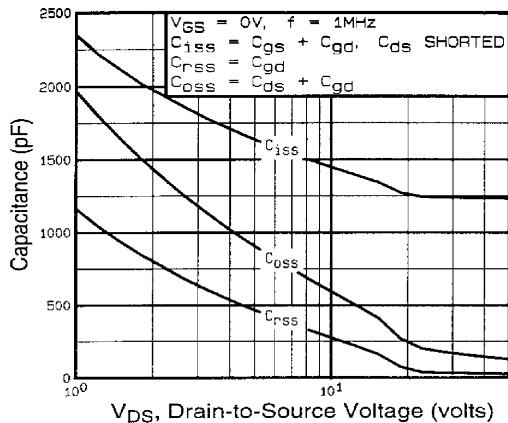

**Fig 5.** Typical Capacitance Vs. Drain-to-Source Voltage

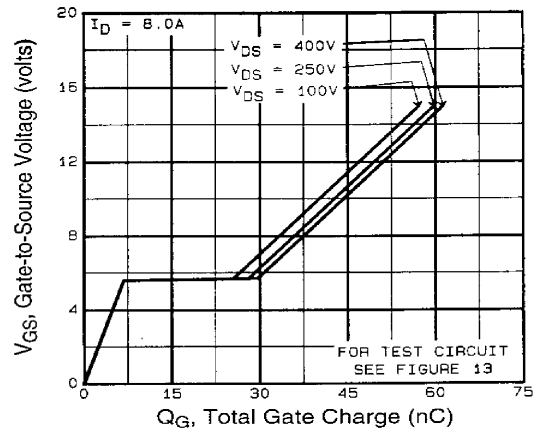

**Fig 6.** Typical Gate Charge Vs. Gate-to-Source Voltage

## N-Channel MOSFET IRF840S (KRF840S)

■ Typical Characteristics

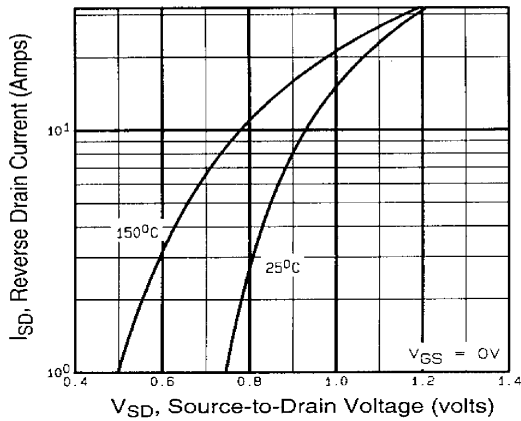

**Fig 7.** Typical Source-Drain Diode Forward Voltage

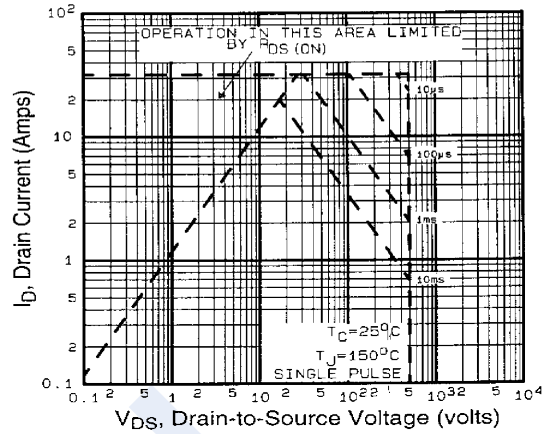

**Fig 8.** Maximum Safe Operating Area

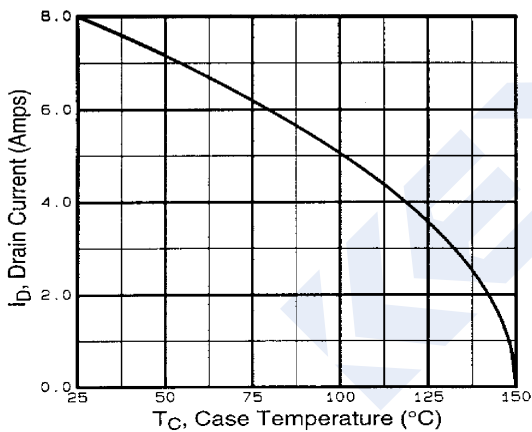

**Fig 9.** Maximum Drain Current Vs. Case Temperature

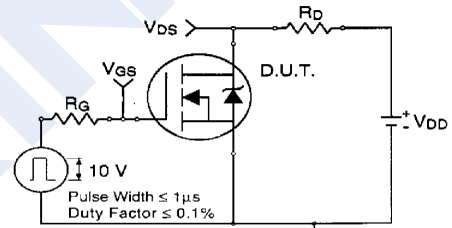

**Fig 10a.** Switching Time Test Circuit

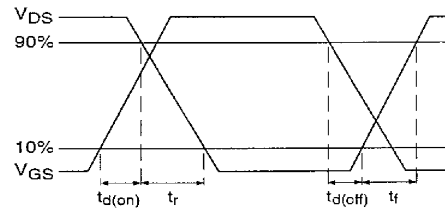

**Fig 10b.** Switching Time Waveforms

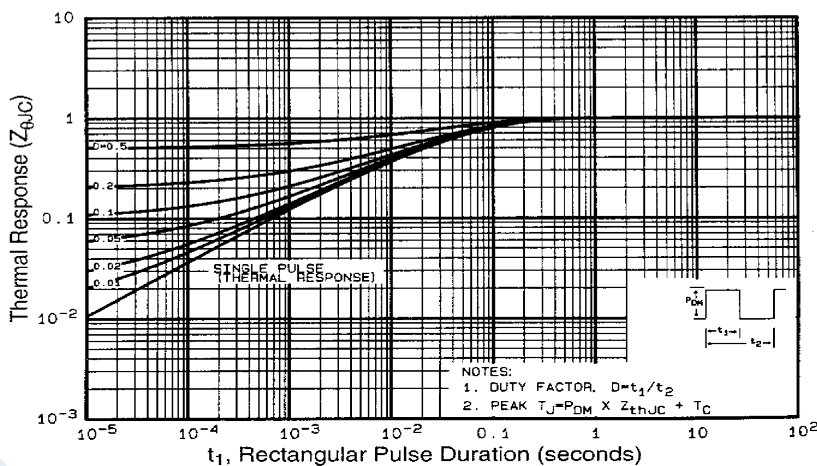

**Fig 11.** Maximum Effective Transient Thermal Impedance, Junction-to-Case

## N-Channel MOSFET IRF840S (KRF840S)

■ Typical Characteristics

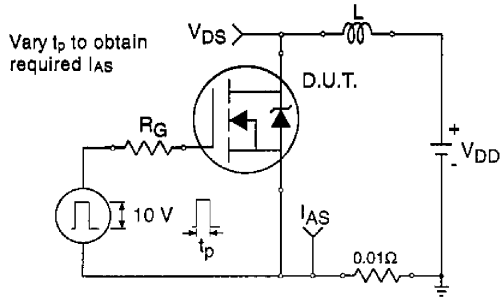

Fig 12a. Unclamped Inductive Test Circuit

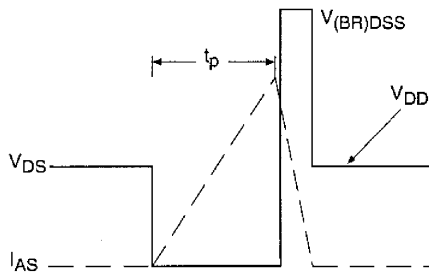

Fig 12b. Unclamped Inductive Waveforms

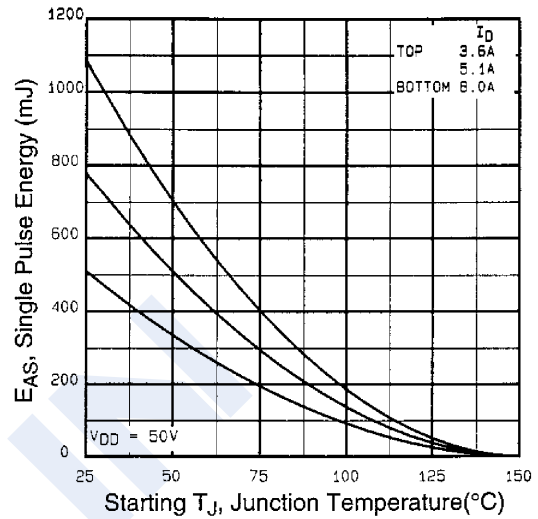

Fig 12c. Maximum Avalanche Energy Vs. Drain Current

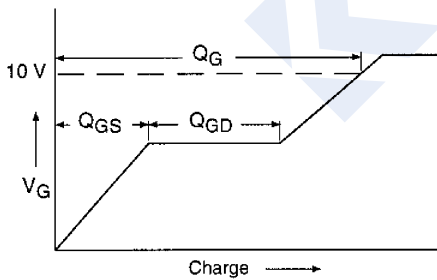

Fig 13a. Basic Gate Charge Waveform

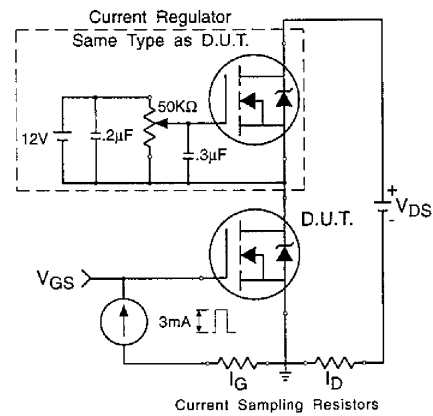

Fig 13b. Gate Charge Test Circuit